









#### 4. ELECTRICAL CHARACTERISTICS

Item	Symbol	Min	Typ	Max	Unit	Note
Power Voltage	VDD	-	3.3	-	V	
LED Power Voltage	VCC	-	12	-	V	
High-level Input Voltage	VIH	0.8Vcc	-	Vcc	V	
Low-level Input Voltage	VIL	GND	-	0.2Vcc	V	
Differential Input High Threshold	VTH	-	-	0.1	V	
Differential Input Low Threshold	VTL	-0.1	-	-	V	

## 5. OPTICAL CHARACTERISTICS

Item	Symbol	Conditions	Min	Typ	Max	Unit	Note
Contrast Ration	CR	Viewing normal angle	-	500	-	-	
Response Time	TR	$\theta_x = \theta_y = 0$	-	5	10	ms	(2)
	TF		-	15	20	ms	
Viewing Angle	Hor.	$\theta_{x+}$	-	70	-	deg	(3)
		$\theta_{x-}$	-	70	-	deg	
	Ver.	$\theta_{y+}$	-	50	-	deg	
		$\theta_{y-}$	-	60	-	deg	
Module Chromaticity	Red	XR	0.550	0.600	0.650		
		YR	0.294	0.344	0.394		
	Green	XG	0.304	0.354	0.404		
		YG	0.529	0.579	0.629		
	Blue	XB	0.105	0.155	0.205		
		YB	0.076	0.126	0.176		
	White	XW	0.240	0.290	0.340		
		YW	0.268	0.318	0.368		
Brightness	-	ILED = 480mA	-	1000	-	Lux	(4)

\*Note (1) These items are measured by BM-7 in the dark room (no ambient light)

\*Note (2) Definition of Response Time (TR,TF) :

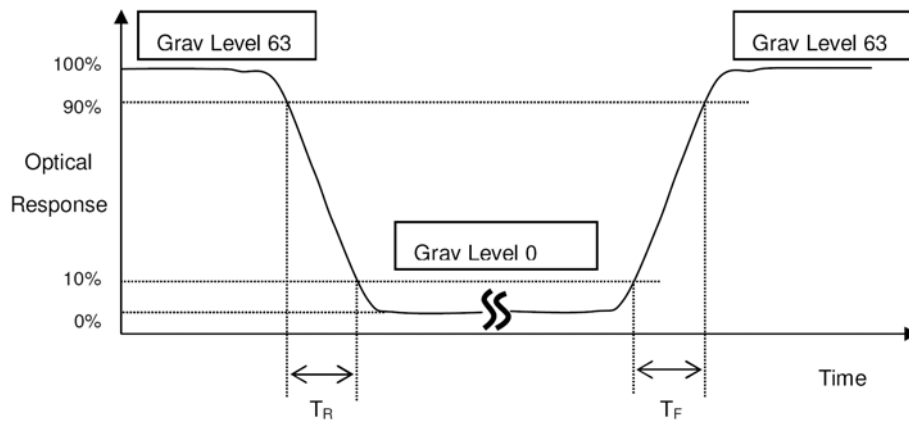

**\*Note (3) Definition of Viewing Angle**

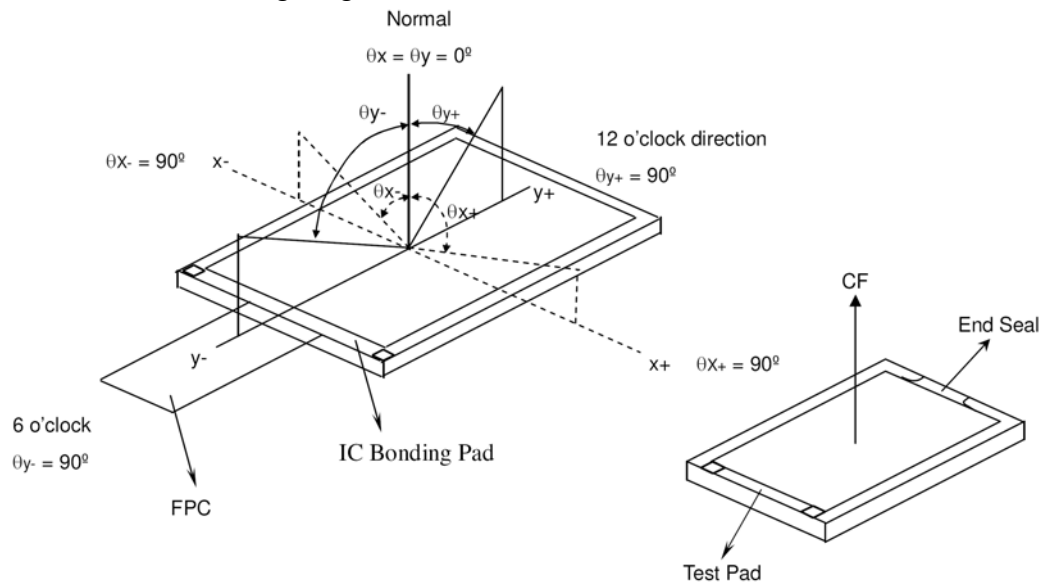

**\*Note (4) The Brightness is at the center of V.A(Viewing Area).**

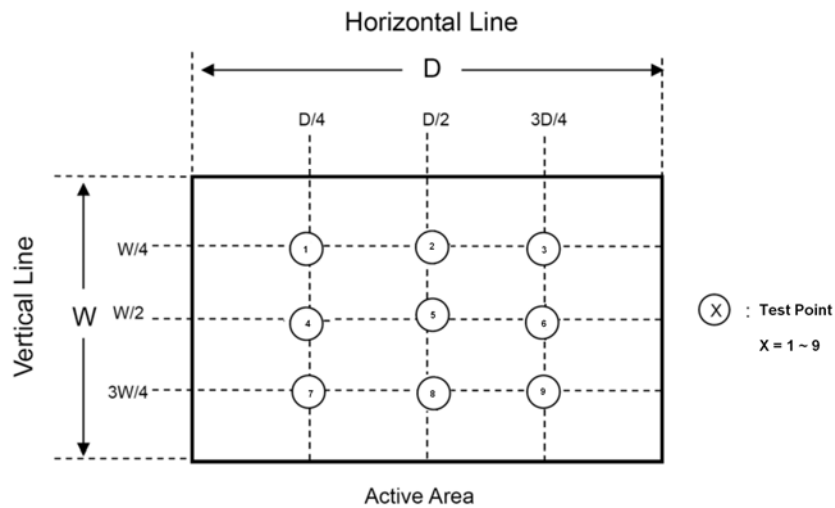

## 6. Backlight Driving Circuit

Item	Symbol	Min	Typ	Max	Unit	Note
LED Voltage	VLED	-	19.8	-	V	
LED Current	ILED	-	480	-	mA	
LED life time	-	-	50,000	-	Hr	
LED DRIVER Power Current	ICC(VCC=12V)	-	940	1175	mA	
Dimming Voltage	-	3	3.3	5.5	V	
Dimming duty cycle	-	5	-	100	%	

### 6.1 PWM Dimming Control

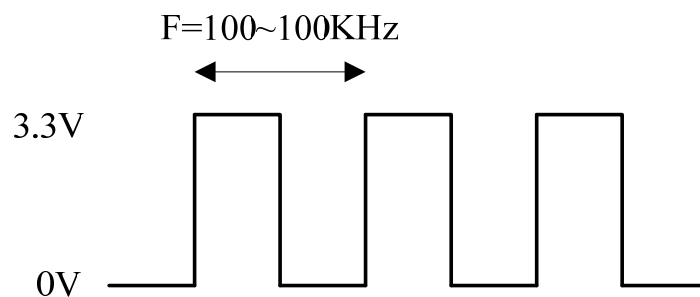
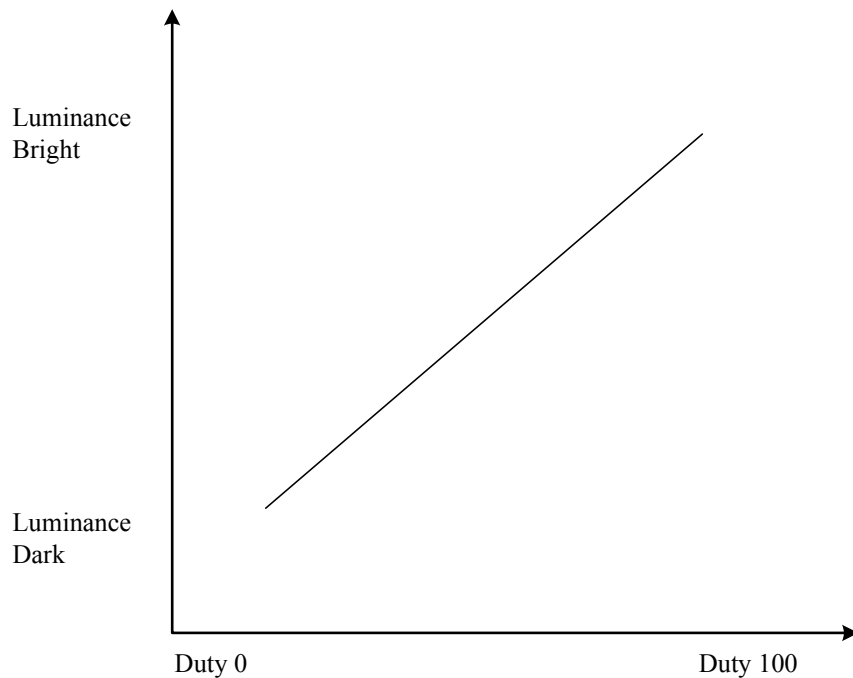



## 7. INTERFACE

### CN1 : LCM PIN Definition

Pin no	Symbol	Function
1	VDD	Power Supply:3.3V
2	VDD	Power Supply:3.3V
3	GND	Power Ground
4	DPS	Reverse Scan Function [H:Enable ; L:Disable]
5	RxIN0-	Transmission Data of Pixels 0
6	RxIN0+	Transmission Data of Pixels 0
7	GND	Power Ground
8	RxIN1-	Transmission Data of Pixels 1
9	RxIN1+	Transmission Data of Pixels 1
10	GND	Power Ground
11	RxIN2-	Transmission Data of Pixels 2
12	RxIN2+	Transmission Data of Pixels 2
13	GND	Power Ground
14	RxCLKIN-	LVDS receiver signal clock
15	RxCLKIN+	LVDS receiver signal clock
16	GND	Power Ground
17	RxIN3-	Transmission Data of Pixels 3
18	RxIN3+	Transmission Data of Pixels 3
19	RSV	Reserved for internal test. Please treat it as NC
20	SEL68	6/8bits LVDS data input selection [H:8bits L:6bits]

**CN2 : Backlight adjustment PIN Definition**

Pin no	Symbol	Function
1	VCC	Power Supply:12V
2	GND	Power Ground
3	ON/OFF	Function selection:5V-Backlight ON , GND-Backlight OFF
4	Dimming	Adjust brightness
5	N/A	No Connection

**CN4 : Backlight Power Source PIN Definition**

Pin no	Symbol	Function
1	A	Power 19.8V
2	K	Power Ground

## 8. Signal Characteristics

### 8.1 Pixel Format Image

Following figure shows the relationship between input signal and LCD pixel format.

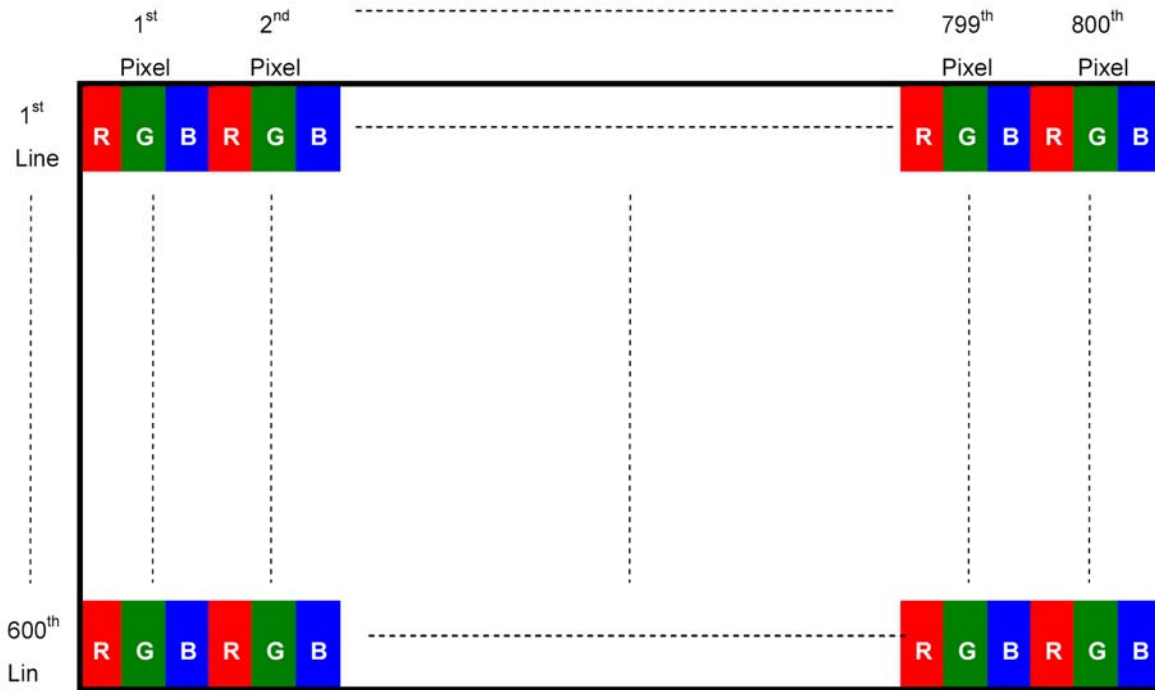

### 8.2 Scanning Direction

The following figures show the image seen from the front view. The arrow indicates the direction of scan.

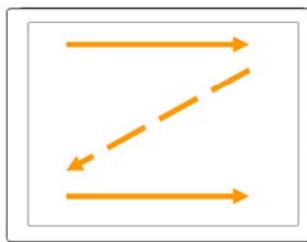

Fig. 1 Normal scan (Pin4, DPS = Low or NC)

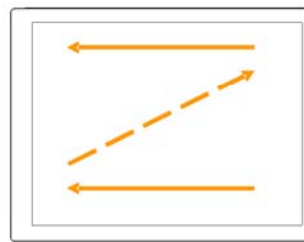
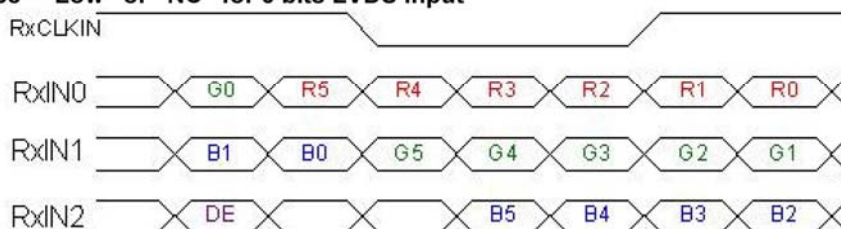

Fig. 2 Reverse scan (Pin4, DPS = High)

### 8.3 The Input Data Format

#### SEL68

**SEL68 = "Low" or "NC" for 6 bits LVDS Input**



**SEL68 = "High" for 8 bits LVDS Input**

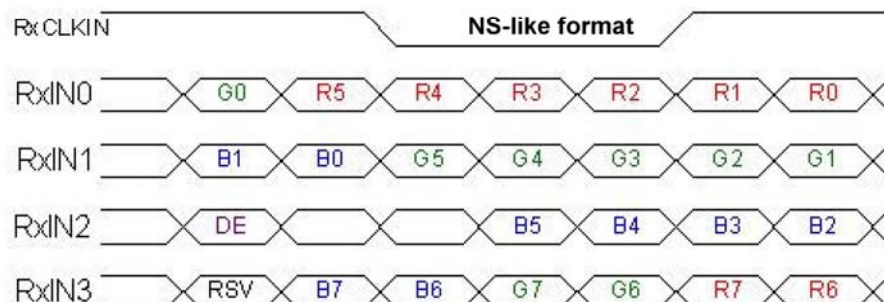

**Note1:** Please follow PSWG.

**Note2:** R/G/B data 7:MSB, R/G/B data 0:LSB

Signal Name	Description	Remark
R7	Red Data 7	Red-pixel Data
R6	Red Data 6	
R5	Red Data 5	
R4	Red Data 4	
R3	Red Data 3	
R2	Red Data 2	
R1	Red Data 1	
R0	Red Data 0	For 8Bits LVDS input MSB: R7 ; LSB: R0
G7	Green Data 7	Green-pixel Data
G6	Green Data 6	
G5	Green Data 5	
G4	Green Data 4	
G3	Green Data 3	
G2	Green Data 2	
G1	Green Data 1	
G0	Green Data 0	For 6Bits LVDS input MSB: G5 ; LSB: G0
B7	Blue Data 7	Blue-pixel Data
B6	Blue Data 6	
B5	Blue Data 5	
B4	Blue Data 4	
B3	Blue Data 3	
B2	Blue Data 2	
B1	Blue Data 1	
B0	Blue Data 0	For 8Bits LVDS input MSB: B7 ; LSB: B0
RxCLKIN	LVDS Data Clock	
DE	Data Enable Signal	When the signal is high, the pixel data shall be valid to be displayed.

Note: Output signals from any system shall be low or Hi-Z state when VDD is off.

## 9. Timing Characteristics

### Horizontal Timing

Parameter	Symbol	Spec.			Unit
		Min.	Typ.	Max.	
Horizontal Display Area	thd	800			DCLK
DCLK frequency	Fclk	-	40	50	MHz
One Horizontal Line	th	862	1056	1200-	DCLK
HS pulse width (Min.)	thpw	1			DCLK
HS pulse width (Typical.)	thpw	-			DCLK
HS pulse width (Max.)	thpw	40			DCLK
HS Back Porch (Blanking)	thb	46	46	46	DCLK
HS Front Porch	thfp	16	210	354	DCLK

### Vertical Timing

Parameter	Symbol	Spec.			Unit
		Min.	Typ.	Max.	
Vertical Display Area	tvd	600			T <sub>H</sub>
VS period	tv	624	635	700	T <sub>H</sub>
VS pulse width	thpw	1	-	20	T <sub>H</sub>
VS Back Porch (Blanking)	tvb	23	23	23	T <sub>H</sub>
VS Front Porch	thfp	1	12	77	T <sub>H</sub>

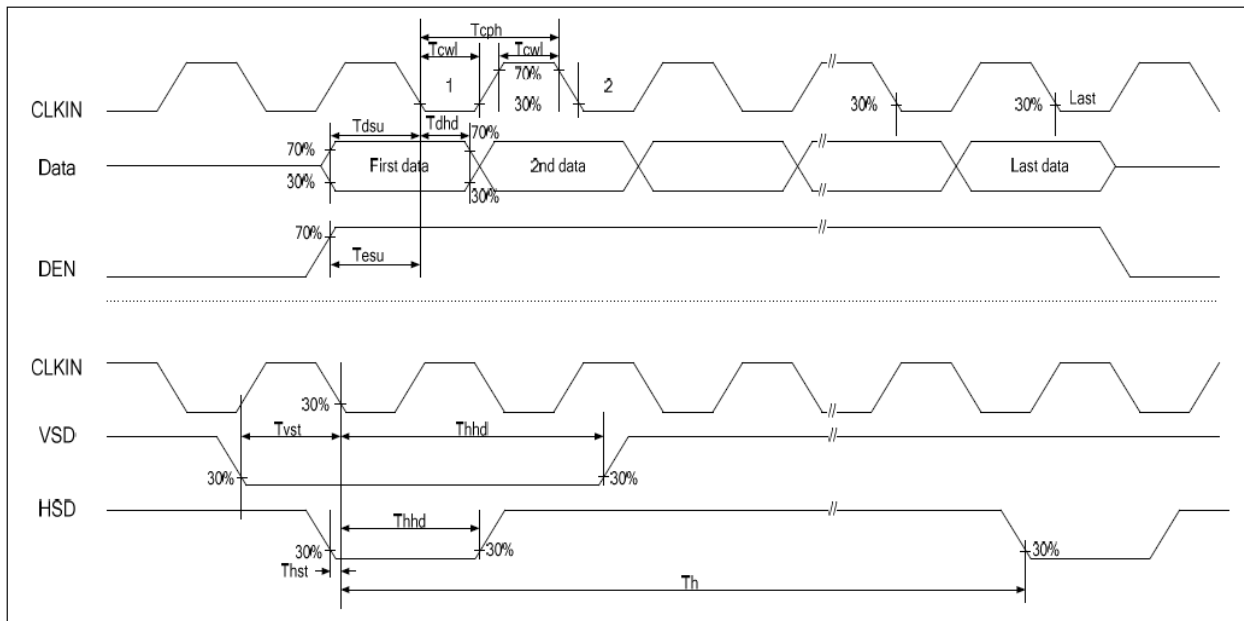

## 10. INCOMING INSPECTION STANDARD

### 10-1. Scope

Specifications contain

10.1 Display Quality Evaluation

10.2 Mechanics Specification

### 10-2. Sampling Plan

Unless there is other agreement, the sampling plan for incoming inspection shall Follow MIL-STD-105E LEVEL II.

10-2.1 Lot size: Quantity per shipment as one lot (different model as different lot ).

10-2.2 Sampling type: Normal inspection, single sampling.

10-2.3 Sampling level: Level II.

10-2.4 AQL: Acceptable Quality Level

Major defect: AQL=0.65

Minor defect: AQL=1.0

### 10-3. Panel Inspection Condition

10-3.1 Environment:

Room Temperature:  $25\pm 5^{\circ}\text{C}$ .

Humidity:  $65\pm 5\%$  RH.

Illumination: 300 ~ 700 Lux.

10-3.2 Inspection Distance:

35-40 cm

10-3.3 Inspection Angle:

The vision of inspector should be perpendicular to the surface of the Module.

10-3.4 Inspection time :

Perceptibility Test Time: 20 seconds max.

### 10-4. Display Quality

10-4.1 Function Related:

The function defects of line defect, abnormal display, and no display are considered Major defects.

### 10-5 Bright/Dark Dots:

Defect Type / Specification	G0 Grade	A Grade
Bright Dots	0	$N \leq 3$
Dark Dots	0	$N \leq 4$
Total Bright and Dark Dots	0	$N \leq 6$

[Note 1]

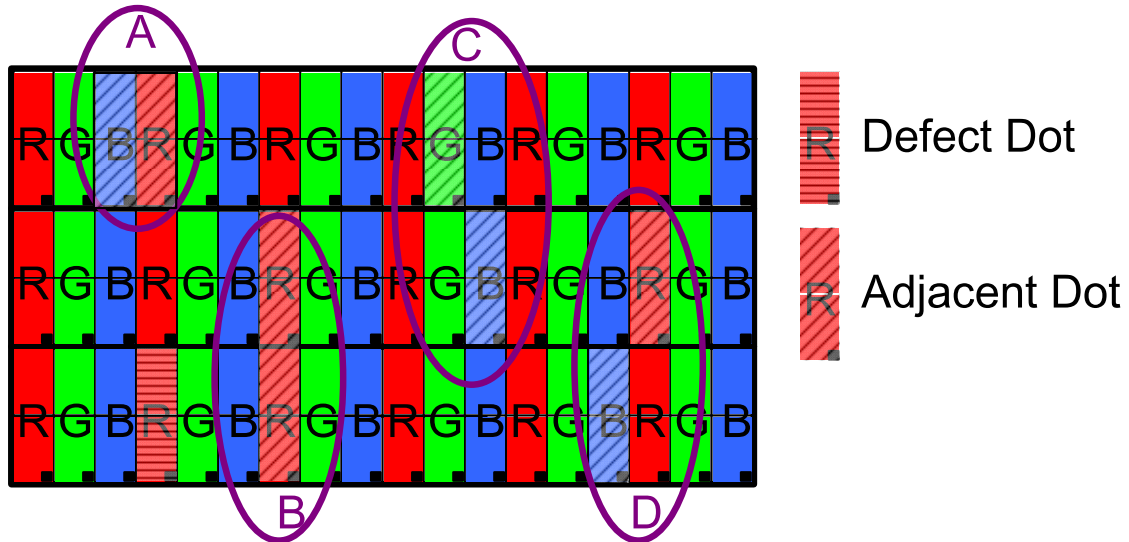

Judge defect dot and adjacent dot as following.

- (1) One pixel consists of 3 sub-pixels, including R,G, and B dot.(Sub-pixel = Dot)
- (2) The definition of dot: The size of a defective dot over 1/2 of whole dot is regarded as one defective dot.
- (3) Allow above (as A, B, C and D status) adjacent defect dots, including bright and dart adjacent dot. And they will be counted 2 defect dots in total quantity.
- (4) Defects on the Black Matrix, out of Display area, are not considered as a defect or counted.
- (5) There should be no distinct non-uniformity visible through 3% ND Filter within 2 sec inspection times.

**10-6 Visual Inspection specifications:**

Defect Type	Specification	Count(N)
Dot Shape (Particle、Scratch and Bubbles in display area)	$D \leq 0.25\text{mm}$	Ignored
	$0.25\text{mm} < D \leq 0.5\text{mm}$	$N \leq 3$
	$D > 0.5\text{mm}$	$N=0$
Line Shape (Particles、Scratch、Lint and Bubbles in display area)	$W \leq 0.07\text{mm}$	Ignored
	$0.07\text{mm} < W \leq 0.1\text{mm}, L \leq 5\text{mm}$	$N \leq 3$
	$W > 0.1\text{mm}, L > 5\text{mm}$	$N=0$

[Note 2] W : Width[mm], L : Length[mm], N : Number,  $\phi$  : Average Diameter

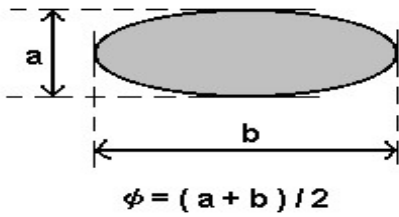

1. (White, black) Spot
2. Polarizer Bubble

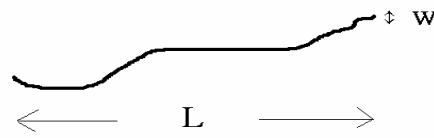

1. fiber

[Note 3] Bright dot is defined through 3% transmission ND Filter as following.

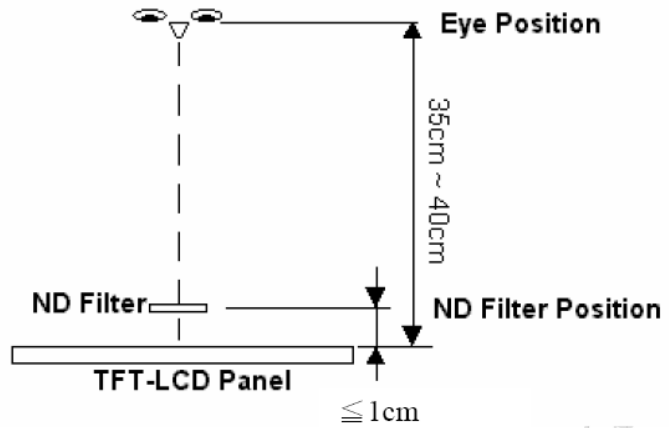
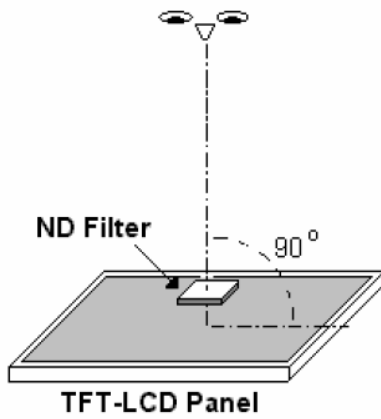



## 11. QUALITY AND RELIABILITY

Test Item	Test Conditions	Note
High Temperature Operation	70±3°C , t=240 hrs	
Low Temperature Operation	-20±3°C , t=240 hrs	
High Temperature Storage	80±3°C , t=240 hrs	1,2
Low Temperature Storage	-30±3°C , t=240 hrs	1,2
Thermal Shock Test	-20°C ~ 25°C ~ 70°C 30 m in. 5 min. 30 min. ( 1 cycle ) Total 5 cycle	1,2
Humidity Test	60 °C, Humidity 90%, 240 hrs	1,2
Vibration Test (Packing)	Sweep frequency : 10 ~ 55 ~ 10 Hz/1min Amplitude : 0.75mm Test direction : X.Y.Z/3 axis Duration : 30min/each axis	2
Electro Static Discharge	±2KV, Human Body Mode, 100pF/1500Ω	

Note 1 : Condensation of water is not permitted on the module.

Note 2 : The module should be inspected after 1 hour storage in normal conditions  
(15-35°C , 45-65%RH).

Definitions of life end point :

- Current drain should be smaller than the specific value.
- Function of the module should be maintained.
- Appearance and display quality should not have degraded noticeably.
- Contrast ratio should be greater than 50% of the initial value.

## **12. USE PRECAUTION**

### **12.1 Handling precautions**

- 1) The polarizing plate may break easily so be careful when handling it. Do not touch, press or rub it with a hard-material tool like tweezers.
- 2) Do not touch the polarizing plate surface with bare hands so as not to make it dirty. If the surface or other related part of the polarizing plate is dirty, soak a soft cotton cloth or chamois leather in benzine and wipe off with it. Do not use chemical liquids such as acetone, toluene and isopropyl alcohol. Failure to do so may bring chemical reaction phenomena and deteriorations.
- 3) Remove any spit or water immediately. If it is left for hours, the suffered part may deform or decolorize.
- 4) If the LCD element breaks and any LC stuff leaks, do not suck or lick it. Also if LC stuff is stuck on your skin or clothing, wash thoroughly with soap and water immediately.

### **12.2 Installing precautions**

- 1) The PCB has many ICs that may be damaged easily by static electricity. To prevent breaking by static electricity from the human body and clothing, earth the human body properly using the high resistance and discharge static electricity during the operation. In this case, however, the resistance value should be approx. 1MΩ and the resistance should be placed near the human body rather than the ground surface. When the indoor space is dry, static electricity may occur easily so be careful. We recommend the indoor space should be kept with humidity of 60% or more. When a soldering iron or other similar tool is used for assembly, be sure to earth it.
- 2) When installing the module and ICs, do not bend or twist them. Failure to do so may crack LC element and cause circuit failure.
- 3) To protect LC element, especially polarizing plate, use a transparent protective plate (e.g., acrylic plate, glass etc) for the product case.

Do not use an adhesive like a both-side adhesive tape to make LCD surface (polarizing plate) and product case stick together. Failure to do so may cause the polarizing plate to peel off.

### **12.3 Storage precautions**

- 1) Avoid a high temperature and humidity area. Keep the temperature between 0°C and 35°C and also the humidity under 60%.
- 2) Choose the dark spaces where the product is not exposed to direct sunlight or fluorescent light.
- 3) Store the products as they are put in the boxes provided from us or in the same conditions as we recommend.

## 12.4 Operating precautions

- 1) Do not boost the applied drive voltage abnormally. Failure to do so may break ICs. When applying power voltage, check the electrical features beforehand and be careful. Always turn off the power to the LC module controller before removing or inserting the LC module input connector. If the input connector is removed or inserted while the power is turned on, the LC module internal circuit may break.
- 2) The display response may be late if the operating temperature is under the normal standard, and the display may be out of order if it is above the normal standard. But this is not a failure; this will be restored if it is within the normal standard.
- 3) The LCD contrast varies depending on the visual angle, ambient temperature, power voltage etc. Obtain the optimum contrast by adjusting the LC drive voltage.
- 4) When carrying out the test, do not take the module out of the low-temperature space suddenly. Failure to do so will cause the module condensing, leading to malfunctions.
- 5) Make certain that each signal noise level is within the standard (L level:  $0.2V_{dd}$  or less and H level:  $0.8V_{dd}$  or more) even if the module has functioned properly. If it is beyond the standard, the module may often malfunction. In addition, always connect the module when making noise level measurements.
- 6) The CMOS ICs are incorporated in the module and the pull-up and pull-down function is not adopted for the input so avoid putting the input signal open while the power is ON.
- 7) The characteristic of the semiconductor element changes when it is exposed to light emissions, therefore ICs on the LCD may malfunction if they receive light emissions. To prevent these malfunctions, design and assemble ICs so that they are shielded from light emissions.
- 8) Crosstalk occurs because of characteristics of the LCD. In general, crosstalk occurs when the regularized display is maintained. Also, crosstalk is affected by the LC drive voltage. Design the contents of the display, considering crosstalk.

## 12.5 Other

- 1) Do not disassemble or take the LC module into pieces. The LC modules once disassembled or taken into pieces are not the guarantee articles.
- 2) The residual image may exist if the same display pattern is shown for hours. This residual image, however, disappears when another display pattern is shown or the drive is interrupted and left for a while. But this is not a problem on reliability.
- 3) AMIPRE will provide one year warranty for all products and three months warrantee for all repairing products.

# 13. OUTLINE DIMENSION

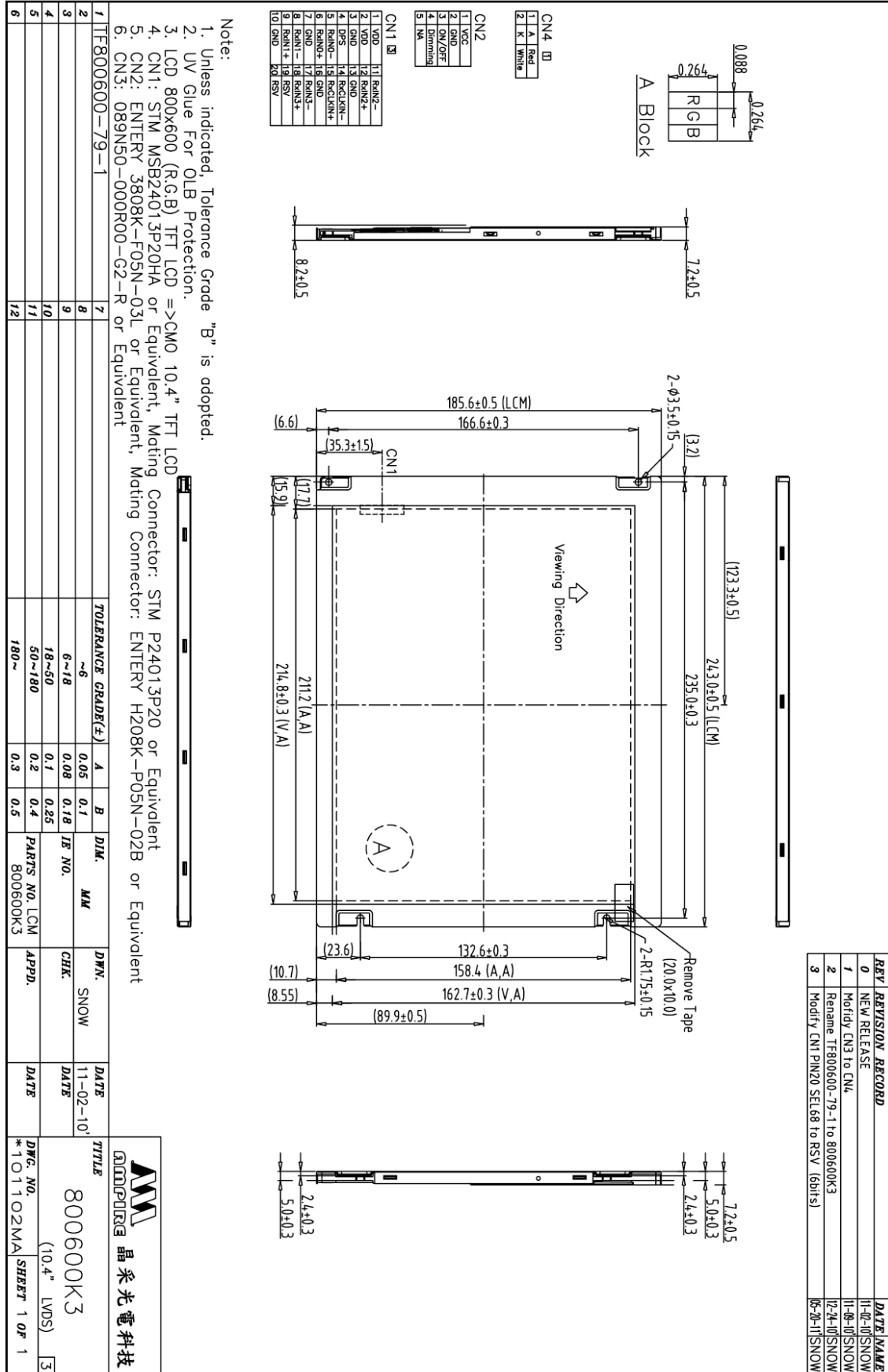

REV	REVISION RECORD	DATE	NAME
0	NEW RELEASE	11-02-10	SNOW
1	Modify CN3 to CN4	11-09-10	SNOW
2	Rename TF800600-79-1 to 800600K3	12-24-10	SNOW
3	Modify CN1 PIN20 SEL68 to RSV (6bits)	05-20-11	SNOW

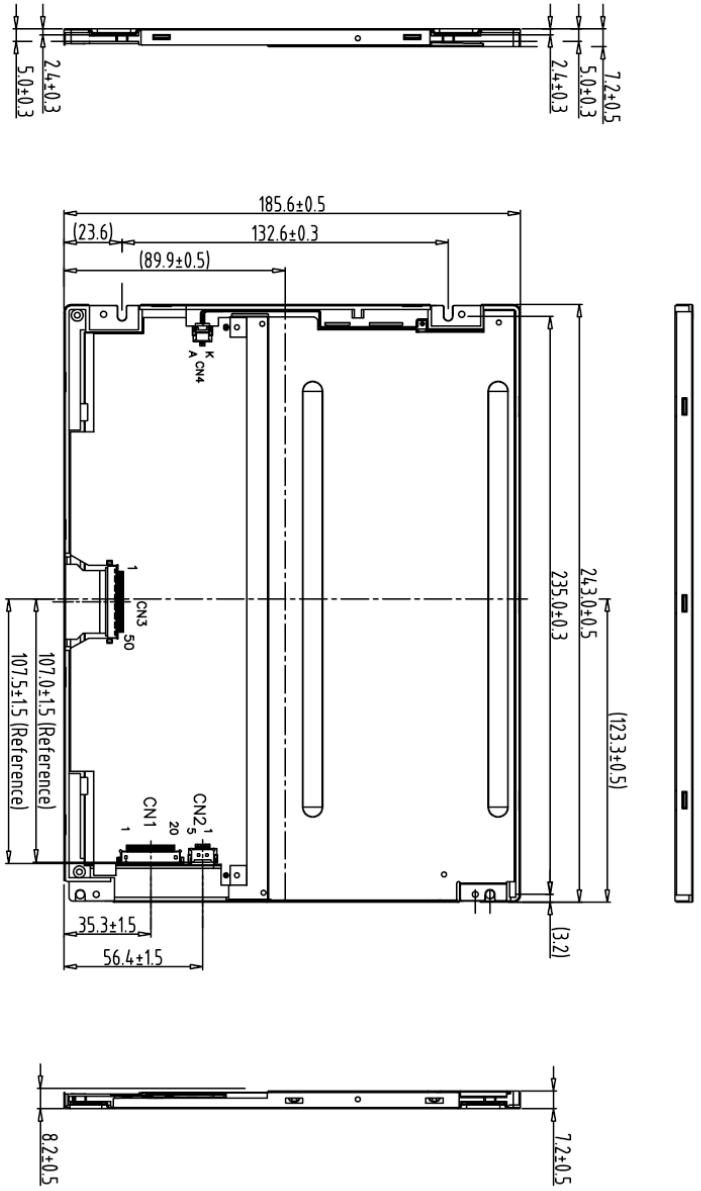

CN4

1	A	Red
2	K	White

CN2

1	VCC
2	GND
3	GND/REF
4	DATA/RSV
5	EN

CN1

1	VDD	11	RAIN2-
2	VDD	12	RAIN2+
3	GND	13	GND
4	DFS	14	RECLKIN-
5	RAIN0-	15	RECLKIN+
6	RAIN0+	16	GND
7	GND	17	RAIN3-
8	RAIN1-	18	RAIN3+
9	RAIN1+	19	RSV
10	GND	20	RSV

Note:

1. Unless indicated, Tolerance Grade "B" is adopted.
2. UV Glue For OLB Protection.
3. LCD 800x600 (R.G.B) TFT LCD =>CMO 10.4" TFT LCD
4. CN1: STM MSB24013P20HA or Equivalent, Mating Connector: STM P24013P20 or Equivalent
5. CN2: ENTERY 3808K-F05N-03L or Equivalent, Mating Connector: ENTERY H208K-P05N-02B or Equivalent
6. CN3: 089N50-000R00-G2-R or Equivalent

1	TF800600-79-1	7	TOLERANCE GRADE(±)	A	B	DIK.	MM	DWN.	SNOW	DATE	TITLE
2		8	~6	0.05	0.1					11-02-10	 晶采光電科技 800600K3 (10.4" LVDS) 3
3		9	6~18	0.08	0.18	IE NO.		CHK.		DATE	
4		10	18~50	0.1	0.25						
5		11	50~180	0.2	0.4	PARTS NO. LCM-1		APPD.			
6		12	180~	0.3	0.5	800600K3					